

POWERMOON[®] LED



info.baltmoon@gmail.com
www.baltmoon.ee
www.powermoon.de



For **25 years** and counting, **POWERMOON's** company name has been synonymous with durability, reliability, craftsmanship and precision.

Advantages of POWERMOON® LED technology



Efficient Lighting

Our lights are glare free, shadow reduced and spreads light in a 360° circle without dark spots.



High Portability

POWERMOON® luminaries are small in storage and easy to set up within minutes.



Superb Quality

All of our products use modern LED technology and are made of the highest quality materials.



Guaranteed Safety

Daylight conditions at night wherever needed! Safe and efficient teamwork guaranteed!



German Engineering

For more than 25 years - all POWERMOON® products are made in Germany.



Weather Resistant

We use only the most durable and weatherproof materials for the harshest working conditions.



POWERMOON® USA - Headquarters



POWERMOON® Germany - Headquarters

POWERMOON® LED SL2000

The POWERMOON® SL is the entry-level model of the POWERMOON® series

„SL“ stands for: super light, 48,000 lumen bright
„SL“ stands for: super light, only 9kg

As bright as 2000W tungsten halogen! But only requires 320W!

- Glare free Light
- Instant On/Off Technology
- Fast Lock „Pull-Down“ solution
- Protection Type IP54, thus rain and weather proof (Continuous use)
- Bottom Cover out of Spinnaker-Nylon
- Made entirely in fiberglass, corrosion-free stainless steel and aluminum
- New LED technology without power supply – Plug in and ready!
- Vibration resistant by LED technology
- Patented spring mechanism system
- No more Cool-down time
- No flickering of the light
- Spring loaded opening mechanism
- Hanging loop
- Soft padded carrying case



POWERMOON® LED LEDMOON®

The POWERMOON® LEDMOON® AC/230V Balloon lights work without an additional power supply! Just plug it in and light it up!

The POWERMOON® LEDMOON® is our unbeatable value-for-money winner which you can get for your money!

No other balloon or floodlight offers a better deal compared to Euro per Lumen! Light works without a power supply. Just plug it in and light it up!

Fold-out suspension-hook

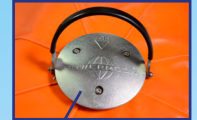

Pull open technology opens balloon light through a simple pull on a cable!

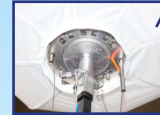

Protection class Protection insulation		POWERMOON® SL2000
Wattage :	320W	
Voltage :	120-230V/ 40-150Hz	
Current :	1,8A at 230V	
Type of protection :	IP 54	
Light amount :	ca. 48,000 Lumen	
Light color :	6000K, daylight quality, CRI >80	
Balloon weight :	9kg	
Ballon dimensions :	D=900mm H=600mm	
Transport packaging :	L=1200mm x B=250mm x H=250mm	
min.Generator W :	500 Watt	

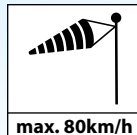
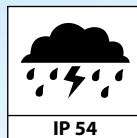

Protection class Protection insulation		LEDMOON® 400	LEDMOON® 600
Wattage :	500W	500W	600W
Voltage :	230V / 50-60Hz	230V / 50-60Hz	230V / 50-60Hz
Current :	2,2 A /120V	2,9A	2,9A
Type of protection :	IP 54	IP 54	IP 54
Light amount :	ca. 50,000 Lumen	75,000 Lumen	75,000 Lumen
Light color :	5500K, CRI >80	5500K, CRI >80	5500K, CRI >80
Balloon weight :	11kg	12kg	12kg
Ballon dimensions :	D=900mm H=600mm	D=900mm H=600mm	D=900mm H=600mm
Transport packaging :	L=1140mm x D=250mm	L=1140mm x D=250mm	L=1140mm x D=250mm
min.Generator W :	500 Watt	700 Watt	700 Watt

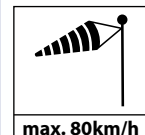
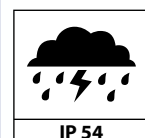

POWERMOON® LED-MASTER



The **POWERMOON® LED-MASTER®** balloons are particularly suitable for operation on road pavers, road rollers or other construction machines by using it directly with the on-board voltage system. Pre-sets for either **12 volts or 24 volts**. The complete cable kit for operation on the vehicle's battery including the power socket for body installation and a **DC high-current switch is included** with the light!

Supplied cable lengths: From the battery to the power outlet: 4meter. From the DC power plug to the POWERMOON® master light 7meter. Special cable lengths for larger vehicles on request.

With optional power supply also usable on household voltage!

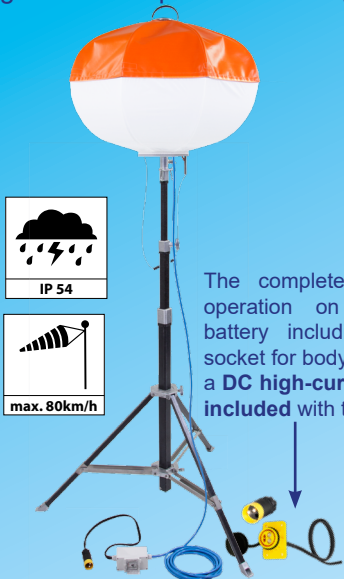

The complete cable kit for operation on the vehicle's battery including the power socket for body installation and a **DC high-current switch are included** with the light!



12V / 24V - 1000W
DC power-pack
IP54



POWERMOON® LED TRANSFORMER®

POWERMOON® TRANSFORMER - A new innovative textile free light system with the same qualities of the balloon light with an impressive **150 000 Lumens**. The 6 triangular light segments can be adjusted individually to create a light field with the right intensity and angle suitable for your exact needs.

The new **POWERMOON® TRANSFORMER** has an IP65 rating and uses a high performance fanless self-cooling system by also staying super lightweight with a modern Aluminium and Magnesium casting.



150000
Lumen

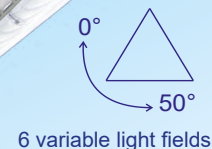

- dim and switch with the all new POWERMOON® smartphone App or manually
- high reliability because of 12 DALI controlled separate circuits
- variable light field because of the patented 6 modules.
 - radial and oval illumination for road construction or track construction possible
- glarefree as if you would have a balloon textile - but its without a textile cover
- daylight in a radius of about 60m or 80-90m on a roadway
- self cooling / passive cooling without fan
- perfect for every construction site, every light tower and as a crane light
- impact resistant polycarbonat glass

Protection class 3 Extra-low voltage area	POWERMOON® LED-MASTER 400	POWERMOON® LED-MASTER 800
	Wattage : 400W	800W
	Voltage : 12V/24V DC	12V/24V DC
	Current : 41A → 12V / 20A → 24V	70A → 12V / 35A → 24V
	Protection Class : IP 54	IP 54
	Light amount : ca. 50,000 Lumen	ca. 100,000 Lumen
	Light color : 5500K, daylight quality, CRI >80	5500K, daylight quality, CRI >80
	Ballon weight : 11kg	13kg
	Ballon dimensions : D=900mm H=600mm	D=1000mm H=750mm
	Transport packaging : L=1140mm x D=250mm	L=1290mm x D=250mm
	Accu/alternator capacity : >80Ah (for 12V vehicle) >40Ah (for 24V) vehicle	>120Ah (for 12V vehicle) >60Ah (for 24V vehicle)



Protection class Protection insulation	POWERMOON® TRANSFORMER	
	Wattage :	1090W
	Voltage :	230V/ 40-150Hz
	Current :	4,7A
	Type of protection :	IP 65
	Light amount :	ca. 150.000 Lumen
	Light color :	5700K, daylight quality, CRI >80
	Ballon weight :	13kg
	Ballon dimensions :	D=690x780mm H=70mm
	Transport packaging :	D=710x800mm H=90mm
	min.Generator W :	1200Watt

POWERMOON® LED SPACE HEXA

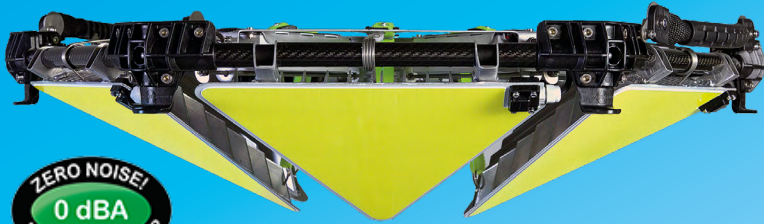

ZERO NOISE!
0 dBA
NO VENTILATOR

The new **POWERMOON®HEXASPACE®** - weighing only **8,8kg** with **110 000 Lumen** - making it the most innovative lightweight LED Work Light on the market!

The **POWERMOON®HEXASPACE®** delivers a 360-degree illumination for a faster, safer and more efficient work environment. It has 6 manually movable light panels to set the perfect lighting angle exactly for your needs. The **POWERMOON®HEXASPACE®** is IP68 - meaning it is completely watertight and can be used in any weather condition (heavy rain/snow).

The **POWERMOON®HEXASPACE®** is compact, efficient and easy to set up. It also comes with two hand grips on the sides for your comfort. Perfect illumination for construction sites, road construction, emergency services, sport and events. High performance fanless self-cooling system.

Comes with the compact **HEXASPACE®** transport bag

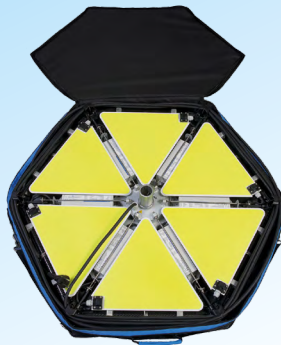

The **HEXASPACE®** panels can easily be brought into the desired light position using Velcro.



easy to carry with handgrips on both sides



Available option: The **HEXASPACE®** balloon cover



The special balloon cover makes the light more glare free. Shadows will be reduced. No dark spots.

Protection class 2
Protection insulation

POWERMOON®HEXASPACE®

Wattage :	900W
Voltage :	220V-240V / 50-60Hz
Current :	4A at 230V
Type of protection :	IP 68
Light amount :	ca. 110000Lumen
Light color :	5500K, daylight quality, CRI >80
Balloon weight :	8,8kg
Ballon dimensions :	D=690x780mm H=70mm
Transport packaging :	D=710x800mm H=90mm
min. Generator W :	1000 Watt

POCKETMOON®

BY
POWERMOON®
LED

The Pocketmoon® is incredibly portable and lightweight being **only 6kg** in total including the light itself, tripod with total height of 3,5m, accessories and the case. The whole set comes in a compact and robust case which resembles a classic rifle case which makes it easy to transport in any situation.



- Weight 400g
- Fits in any pocket

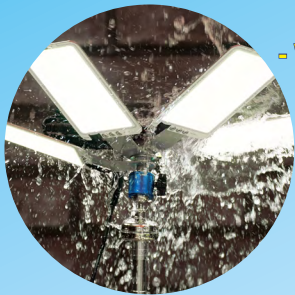

- Waterproof

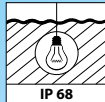

Daylight for any situation!

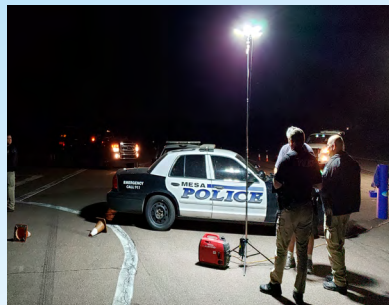

POCKETMOON® SET

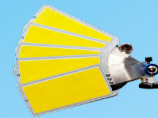

LED panels



120V AC Power supply & cable

3,5m stainless steel tripod with swivel head, magnetic connectors and waterweight



Alligator clips for car battery



Car adapter

optional items:

- Special **balloon cover** for glare-free light.



- **Lithium-ion battery pack** with 10 Amp's. Up to 4 hours running time!



HOBBY POCKETMOON[®]

BY
POWERMOON[®]
LED

The new **HOBBY POCKETMOON[®]** is the most practical solution for any work situation that requires compact, high-quality lighting. The luminaire can be used with both mains and battery power and is shockproof and waterproof, making it ideal for both indoor and outdoor use. Uses of the light are limitless, ranging from interior work such as plastering and painting or working on your car in a garage.

The **HOBBY POCKETMOON[®]** is extremely compact and operates on both **AC and DC** battery power, which makes it possible to use the light in every situation you can think of!

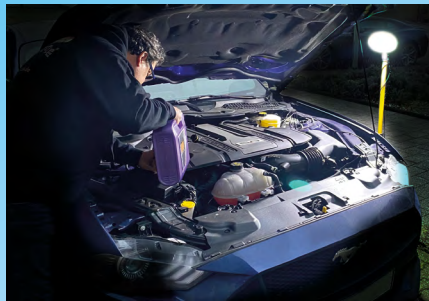
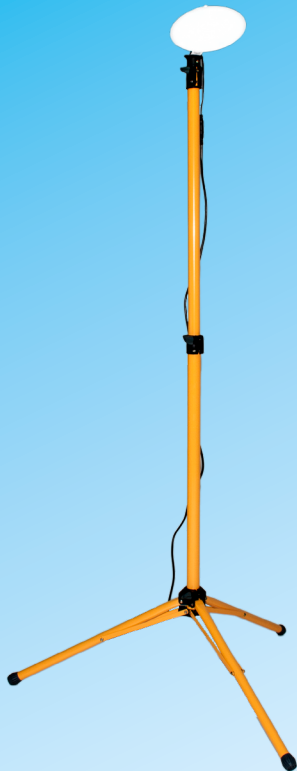

The complete **HOBBY POCKETMOON[®] Set** includes the LED panel, 120V AC Power supply & Cable, alligator clips for car battery, car adapter and steel tripod. All in a compact transport bag.

POWERMOON[®] FIBERJACK[®]

The new POWERMOON[®] Fiberglass Tripod

The new and outstanding fiberglass tripod offers enormous advantages compared to conventional tripods. **POWERMOON[®]** fiberglass tripods are non-corrosive and non-conductive. As a result, there is no longer any danger in rail tracks or overhead power lines. The bending of the tripod segments is history now, as fiberglass finds its way back into its initial form. **Weighing just 9,9kg at a maximum height of 3,20m** makes the fiberglass tripod an absolute lightweight among the tripods. Compared to a commercially available steel telescope tripod, it is about 30% of the weight with the same maximum telescope length.

FIBERJACK[®]

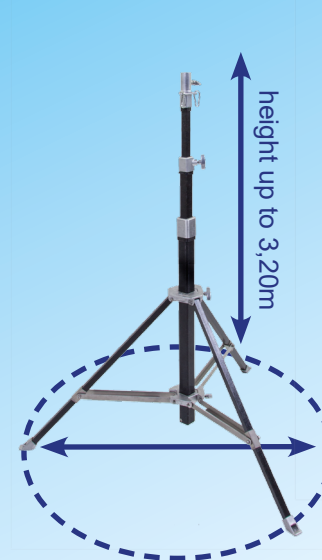

Footprint Diameter 1,40m

FIBERJACK[®] GRAND

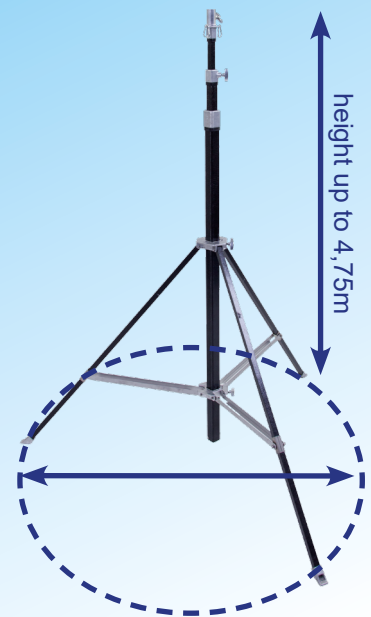

Footprint Diameter 2m

	FIBERJACK [®]	FIBERJACK [®] GRAND
max. Height :	3,20m	4,75m
Transportlength :	1,22m	1,75m
Weight :	9,9kg	14,2kg
Material :	Fiberglass composite (GRP)	Fiberglass composite (GRP)
Amatures :	Aluminum / stainless steel	Aluminum / stainless steel
Tripod Intake :	DIN standard spigot / swivel head	DIN standard spigot / swivel head
Headweight :	25kg	25kg

* included tie down set

POWERMOON® SLIDER Mini-Light-Tower

The new portable **POWERMOON® SLIDER** can be used as a Mini-Light-Tower, but also as a safe stand for mobile traffic lights, warning / information signs and temporary roadblocks.

The most efficient and economic light tower

- **Completely made out of plastic**
(plastic with fiberglass load, no need for grounding, no risk of corrosion)
- **No tie down set needed**
- **Maximum road safety**
(full-round collision protection, without sharp corner or edges)
- **Storm-proof stand**
(stand with 250l of water)
- **Super portable**
(33kg Transportweight)
- **Maximum height**
(going up to 6m)



Generator
mounting surface
Length x width 70cm x 50cm

Forklift access on the bottom





POWERMOON[®] LED



Official dealer for - Estonia / Latvia / Lithuania

Baltmoon OÜ,
Jalaka 48, 50109 Tartu
tel +372 503 6896

www.baltmoon.ee
info.baltmoon@gmail.com